

LED 8" and 12" Traffic Signal Module IL6-P3/P2 Series Incandescent Look Ball

Leading the LED Industry Since 1992
With over 7,000,000 units installed globally



Superior Performance and Reliability





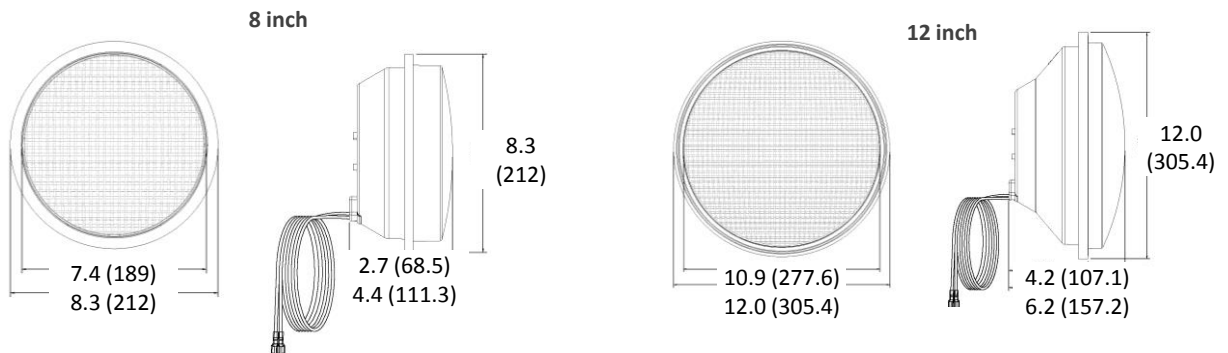







- Unique masking options available
- Intertek ETL verified
- Meets and/or exceeds all ITE standards ITE VTCSH LED Circular Signal Supplement dated June 27th 2005
- More energy efficient than previous model
- Easy installation into existing signal housings
- Patented innovative optical technology
- Wider viewing angle and enhanced uniformity
- Maintains 70% of the initial lumen intensity after 100,000 hours of operation
- Overmolded electrical connectors provide fully-weatherized seal
- Excellent moisture and dust resistance
- Utilizes constant current source to maintain consistent light output
- Superior thermal management
- Environmentally friendly
- 5-year limited warranty

Mechanical Dimensions [in(mm)]



Model Specifications and Ordering Options

Operating Temperature:	-40°F to 165°F (-40°C to 74°C)	Turn-On/Turn-Off Time:	< 75msec
Operating Voltage:	80 - 135Vac	Turn-Off Voltage:	> 35Vac
Power Factor:	> 0.90	Total Harmonic Distortion (THD):	< 20%

	Model Number and Color	Wattage Drawn	Voltage	Dominant Wavelength	Maintained Intensity (cd)		
					Min.	Standard	
IL6-P3	8 inch ball						
	TSL-08R-LX-IL6-A1-P3		5.5	80-135Vac	626	165	ITE 2005/ETL
	TSL-08Y-LX-IL6-A1-P3		6	80-135Vac	589	410	ITE 2005/ETL
	TSL-08G-LX-IL6-A1-P3		6	80-135Vac	500	215	ITE 2005/ETL
	12 inch ball						
	TSL-12R-LX-IL6-A1-P3		5.6	80-135Vac	626	365	ITE 2005/ETL
	TSL-12Y-LX-IL6-A1-P3		8.8	80-135Vac	589	910	ITE 2005/ETL
	TSL-12G-LX-IL6-A1-P3		6.7	80-135Vac	500	475	ITE 2005/ETL
	IL6-P2	8 inch ball					
TSL-08R-LX-IL6-A1-P2			6	80-135Vac	626	165	ITE 2005/ETL/Caltrans
TSL-08Y-LX-IL6-A1-P2			6.8	80-135Vac	589	410	ITE 2005/ETL/Caltrans
TSL-08G-LX-IL6-A1-P2			6	80-135Vac	500	215	ITE 2005/ETL/Caltrans
12 inch ball							
TSL-12R-LX-IL6-A1-P2			6.9	80-135Vac	626	365	ITE 2005/ETL/Caltrans
TSL-12Y-LX-IL6-A1-P2			11.2	80-135Vac	589	910	ITE 2005/ETL/Caltrans
TSL-12G-LX-IL6-A1-P2			6.7	80-135Vac	500	475	ITE 2005/ETL/Caltrans

Please note: Tinted lens standard, clear lens optional. When ordering clear lens, please add "-CLR" to model number. Both tinted and clear lens are Intertek ETL Verified.

Standard Conformance

- FCC Compliant for Electrical Noise
- MIL-STD-810F Moisture Resistant
- MIL-STD-883 Mechanical Vibration
- NEMA TS2 Transient Voltage Protection over 2000V

ITE VTCSH Compliance - LED Circular Signal Supplement – June 27, 2005

- Conditioning ITE 6.4.2 · Luminous Intensity ITE 6.4.4.1-4
- Mechanical Vibration ITE 6.4.3.1 · Chromaticity ITE 6.4.4.6
- Temperature Cycling ITE 6.4.3.2 · Current Consumption ITE 6.4.6.1

