



LED Display Product Data Sheet LTC-5836JD

Spec No.: DS30-2001-143

Effective Date: 10/29/2001

Revision: -

LITE-ON DCC

RELEASE

BNS-OD-FC001/A4

FEATURES

- * 0.52 INCH (13.2 mm) DIGIT HEIGHT.
- * CONTINUOUS UNIFORM SEGMENTS.
- * LOW POWER REQUIREMENT.
- * EXCELLENT CHARACTERS APPEARANCE.
- * HIGH BRIGHTNESS & HIGH CONTRAST.
- * WIDE VIEWING ANGLE.
- * SOLID STATE RELIABILITY.
- * CATEGORIZED FOR LUMINOUS INTENSITY.

DESCRIPTION

The LTC-5836JD is a 0.52 inch (13.2 mm) digit height triple LED display. This device utilizes AllnGaP Hyper Red LED chips, which are made from AllnGaP on a non-transparent GaAs substrate, and has a gray face and white segments.

DEVICE

PART NO.	DESCRIPTION
AllnGaP Hyper Red	Common Anode
LTC-5836JD	R.t Hand Decimal

PACKAGE DIMENSIONS

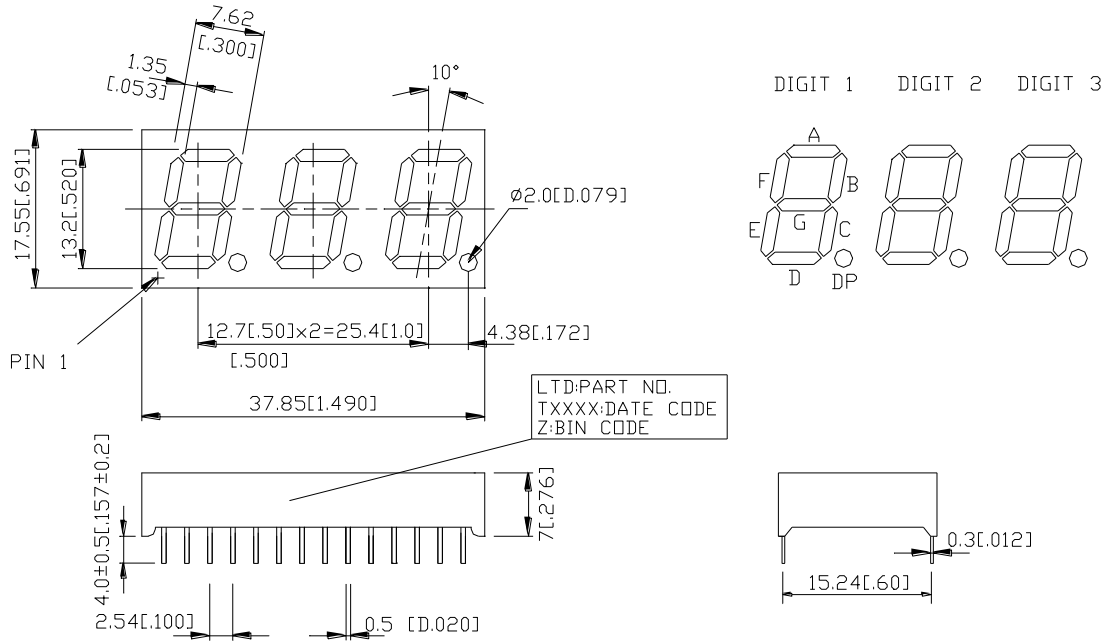

NOTES: All dimensions are in millimeters. Tolerances are ± 0.25 -mm (0.01") unless otherwise noted.

INTERNAL CIRCUIT DIAGRAM

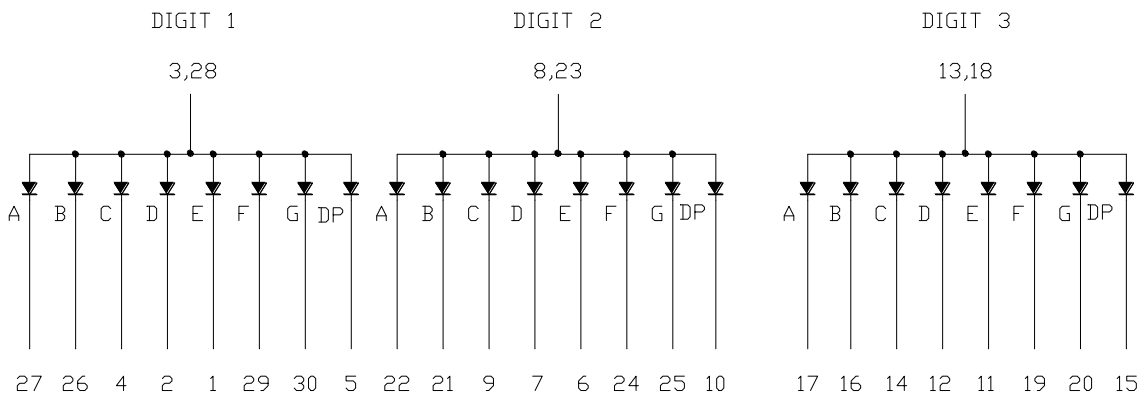

PIN CONNECTION

NO	CONNECTION	NO	CONNECTION
1	CATHODE E (DIGIT 1)	16	CATHODE B (DIGIT 3)
2	CATHODE D (DIGIT 1)	17	CATHODE A (DIGIT 3)
3	COMMON ANODE (DIGIT 1)	18	COMMON ANODE (DIGIT 3)
4	CATHODE C (DIGIT 1)	19	CATHODE F (DIGIT 3)
5	CATHODE D.P. (DIGIT 1)	20	CATHODE G (DIGIT 3)
6	CATHODE E (DIGIT 2)	21	CATHODE B (DIGIT 2)
7	CATHODE D (DIGIT 2)	22	CATHODE A (DIGIT 2)
8	COMMON ANODE (DIGIT 2)	23	COMMON ANODE (DIGIT 2)
9	CATHODE C (DIGIT 2)	24	CATHODE F (DIGIT 2)
10	CATHODE D.P. (DIGIT 2)	25	CATHODE G (DIGIT 2)
11	CATHODE E (DIGIT 3)	26	CATHODE B (DIGIT 1)
12	CATHODE D (DIGIT 3)	27	CATHODE A (DIGIT 1)
13	COMMON ANODE (DIGIT 3)	28	COMMON ANODE (DIGIT 1)
14	CATHODE C (DIGIT 3)	29	CATHODE F (DIGIT 1)
15	CATHODE D.P. (DIGIT 3)	30	CATHODE G (DIGIT 1)

ABSOLUTE MAXIMUM RATING AT T_A=25°C

PARAMETER	MAXIMUM RATING	UNIT
Power Dissipation Per Segment	70	mW
Peak Forward Current Per Segment (1/10 Duty Cycle, 0.1ms Pulse Width)	90	mA
Continuous Forward Current Per Segment Derating Linear From 25°C Per Segment	25 0.33	mA mA/°C
Reverse Voltage Per Segment	5	V
Operating Temperature Range	-35°C to +85°C	
Storage Temperature Range	-35°C to +85°C	
Solder Temperature 1/16 inch Below Seating Plane for 3 Seconds at 260°C		

ELECTRICAL / OPTICAL CHARACTERISTICS AT T_A=25°C

PARAMETER	SYMBOL	MIN.	TYP.	MAX.	UNIT	TEST CONDITION
Average Luminous Intensity	I _v	320	700		μcd	I _F =1mA
Peak Emission Wavelength	λ _p		650		nm	I _F =20mA
Spectral Line Half-Width	Δλ		20		nm	I _F =20mA
Dominant Wavelength	λ _d		639		nm	I _F =20mA
Forward Voltage Per Segment	V _F		2.1	2.6	V	I _F =20mA
Reverse Current Per Segment	I _R			100	μA	V _R =5V
Luminous Intensity Matching Ratio	I _v -m			2:1		I _F =1mA

Note: Luminous intensity is measured with a light sensor and filter combination that approximates the CIE (commission internationale DE L'clairage) eye-response curve.

TYPICAL ELECTRICAL / OPTICAL CHARACTERISTIC CURVES

(25°C Ambient Temperature Unless Otherwise Noted)

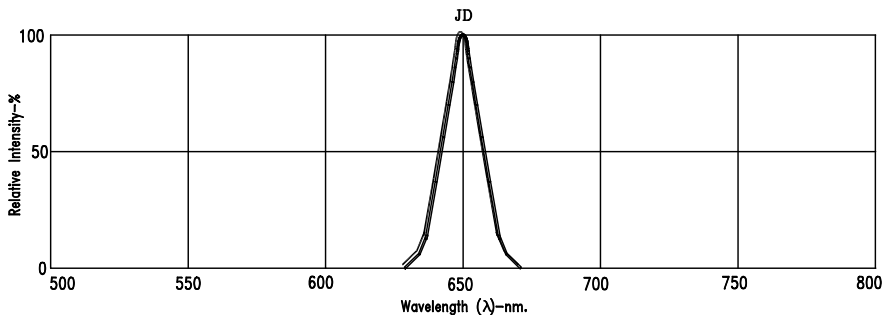

Fig1. RELATIVE INTENSITY VS. WAVELENGTH

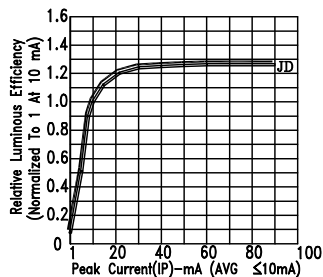

Fig2. RELATIVE LUMINOUS EFFICIENCY (LUMINOUS INTENSITY PER UNIT CURRENT) VS. PEAK CURRENT

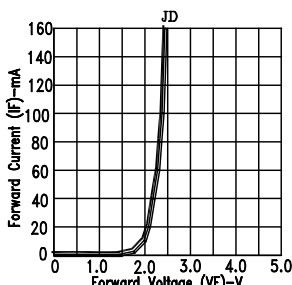

Fig3. FORWARD CURRENT VS. FORWARD VOLTAGE

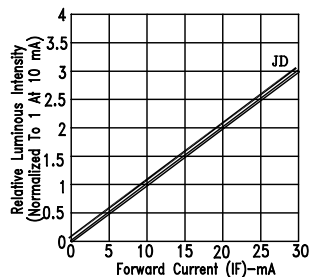

Fig4. RELATIVE LUMINOUS INTENSITY VS. FORWARD CURRENT

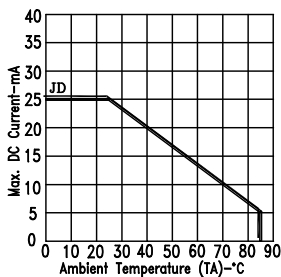

Fig5. MAX. ALLOWABLE DC CURRENT VS. AMBIENT TEMPERATURE.

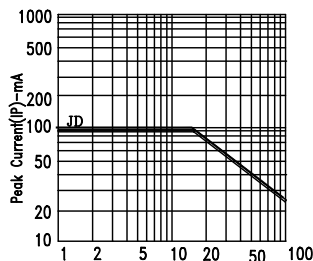

Fig6. MAX. PEAK CURRENT VS. DUTY CYCLE % (REFRESH RATE 1KHz)

NOTE : JD=AlInGaP HYPER RED